



HEAVY DUTY SOLUTIONS FROM REO



A woman with dark hair tied back, wearing glasses, a grey houndstooth coat, and an orange turtleneck, is sitting on a brown leather train seat. She is holding an open book in her lap and looking out of a window to her right. The background is slightly blurred, suggesting motion.

REO

Train Power Magnetics

**ALLOWING YOU TO ENJOY THE
JOURNEY IN FULL: COMPONENTS
FROM REO**



RAILWAY TECHNOLOGY FROM REO

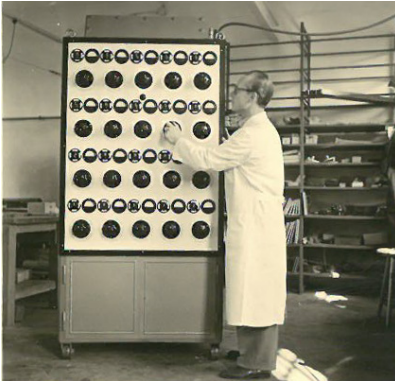

From Solingen into the world: Established in Berlin back in 1925, nowadays REO is a pioneering medium-sized family-run business and market leader in component construction.



Sven Reimann, Member of the Executive Board of REO AG, Head of Development

„In salty air, fine dust or incredibly challenging conditions, REO railway technology components ensure disruption-free and low maintenance operation.“

Trust, sustainability and excellent quality

As a family-run business, we think and act with long-term objectives in mind. As a result, we aim to make products that you can rely on in the long term. We fully believe that our development and production experience, our use of high quality materials, as well as our commitment to conserving resources, are fundamental to ensuring durable products, reliability and satisfied customers. This is why our product portfolio, featuring innovative solutions, and the REO brand are highly regarded on the market globally. What makes us stand out is the fact that we do not just make standard products; we also develop customised products designed to cater for specific requirements.

Used across all sectors: Railway technology

The traditional distribution of sectors is increasingly being dismantled as the product landscape becomes ever more networked and holistic. For our products, this means new areas of application in which railway technology components are increasingly being used. As electrification continues to progress, this has resulted in new applications in mining, shipbuilding and heavy construction machinery. The high dynamic forces, adverse environments and intensive continuous operation involved demand excellent quality. Thanks to our experience and our insulation and moisture protection system developed in-house, our products are perfectly adapted to deal with these harsh conditions.

Yours, Sven Reimann





HEAVY DUTY

In industrial settings, components need to work safely in difficult environmental conditions over many years. As an example, they need to be resistant in particular to extreme temperatures, pollutants such as salts, gases, coal dust, oil or brake abrasion.

WORKING TOGETHER TO CREATE PRODUCTS



REO technology and innovation

Here at REO, we make standard products, modified products and products designed to cater for your specific application. As long as they are physically possible, there are no limits to what can be achieved. The first step towards finding the right REO product is to request information, either by using the product finder on the REO website or by completing the contact form, for example. You do not need to have any technical background knowledge to do this; all you have to do is write to us and tell us what the planned application is.

Will one of the standard products be the right choice?

We will find the best solution for you taking into account the electrical,



mechanical and environmental requirements for your components. As a customer, you can benefit from our experience when purchasing standard products. Our railway technology is a good example of this. Many standard products have already gone through stringent tests here and passed them. We draw on our experience to check for you which product can be used with which configuration. In terms of which tests are specifically required and which ones are not, this will depend on the specific product or project in question. You can discuss this in detail with our experts at REO. Transferring standard products from one particular area of application to another is also generally possible, sometimes without the need for any changes to be made. You can, for



example, benefit from the high levels of protection or compact product dimensions found in the field of railway technology in other fields as well.

Modified standard products

If, however, one of the standard products from REO's product catalogue is not entirely in line with your requirements, it can often be modified. REO's product experts therefore work together with you to check whether there are already products available in REO's product catalogue that can be used as a modified standard product in line with the new requirements. By making changes and undertaking simulation, REO can then examine how the components can be adapted to cater for the new conditions.

The ability to draw on REO's experience and interpolate these new values saves development time and project costs.

Customised development

REO is focused on the development and production of specialist niche solutions in house. If we are unable to find any suitable standard products after analysing your product requirements, REO can then begin developing the required product. Our development work is focused on finding the best possible solutions for your specific electrical, mechanical and environmental requirements. We use digital simulation to subject the components to virtual test runs even before the first prototype is built. In terms of ensuring the best possible value for money, the right technology and components are therefore determined while making optimum use of materials. ◀

Customised development by REO:
Proportionate and experience-based.





In order to conserve materials and shorten development times, or, in other words, to minimise costs, we use the very latest computers and software to simulate mechanical loads, thermal conduction and thermal radiation.

REO TECHNOLOGY AND INNOVATION

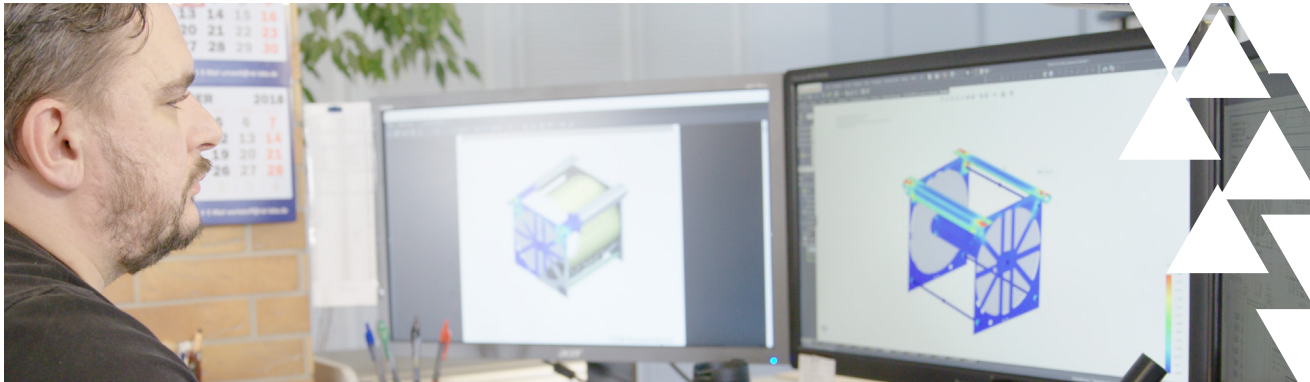

REO technology and innovation

With regard to new developments, highly sophisticated analytical methods have always been at the forefront of product development and improvement. We are also constantly focused on developing technologies further. A full repertoire of technology, analysis and testing ensures that we can fulfil the most stringent of quality requirements. By focusing on modern production methods, efficient workflows, close collabora-

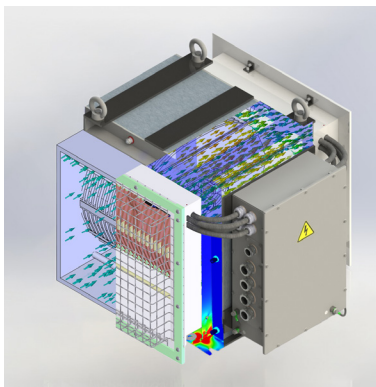

Visualisation of a flow simulation within a frame core choke



tion with universities and the constant advancement and improvement of products and processes, REO is on hand every single day to support customers with products that contribute to the safety, functionality and global growth of railway technology.

Save time and money with simulation

We set the very highest standards and place the most stringent demands on the manufacture of our products. This starts right at an early stage of the product development process by way of detailed simulation. Our work is therefore focused on the specific electrical, mechanical and environmental requirements for your components. We draw on our experience as the



basis for supporting you in implementing your ideas and requirements. In terms of ensuring the best possible value for money, the components can be examined and optimised beforehand by performing magnetic field simulation and FEM thermal simulation. We can also perform life cycle calculations for bolts and weld seams, or examine the impact of cyclic loads by conducting FEM structural mechanical analyses. Thanks to this targeted analysis, REO is able to respond very promptly to your specific requirements and significantly reduce development times.

-25% power loss thanks to REO EDGE-WINDING

REO continues to advance the use of EDGE Winding technology with the introduction of the latest generation N CNW choke and filter series. With greater effectiveness combined with reduced weight at the same time, the new series with edgewise winding boasts extra efficient cooling thanks to its single layer structure, particularly with forced cooling. Due to better cooling, aluminium conductors may be used as a replacement for copper conductors depending on design. As a result, production costs were able to be reduced even further thanks to the interaction with the automated production process. The reduced weight and smaller dimensions are possible thanks to the reduction of skin and proximity losses. EDGE Winding is particularly well suited for semiconductors based on new materials like silicon carbide (SiC) and gallium carbide (GaN). Due to the lower winding capacity, the edgewise winding can also be used at higher frequencies. The life cycle is increased as practically no insulation material is required. "This edge-winding technology is an innovation from our development team, which is constantly developing the latest technologies and always comes across new approaches as a result. We recognised the opportunities that came with this new winding technology and have been able to start small scale or serial production since 2020, offering you extremely fast delivery times.

Liquid cooling of REO

Traditional methods of air cooling encounter their limits at the latest when limited space refuses to permit optimal air circulation from being realised or, due to ambient conditions, cooling using the ambient air is not possible. To continue ensuring the best possible cooling, a wide range of REO inductive and resistive components are equipped with water cooling. The use of a water cooling system not only enables optimal temperature characteristics for the component, but also enables improved power density and

improves the life cycle of the component. The liquid cooling method is a very efficient option for drawing heat away from hotspots and achieving the optimum temperature within the component. The initial higher investment costs involved in the water cooling technology are quickly offset by all kinds of benefits. ◀



Efficient cooling thanks to single layer design for REO EDGE-WINDING



Optimum cooling thanks to REO water cooling system

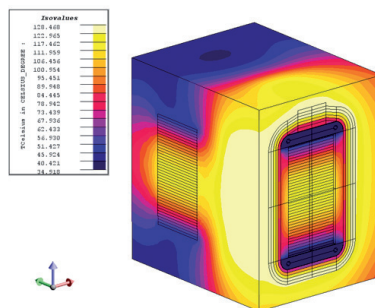

Simulation of thermal behaviour on a REO component



REO offers a wide range of water-cooled components



This edge-winding technology is an innovation from our development team, which is constantly researching the latest technologies and always comes across new approaches as a result.

HEAVY DUTY

REO products are used in the most adverse conditions all over the world, in temperatures of more than 40 °C in deserts or at -50 °C in mountainous regions. It is essential that water, salt, corrosive media and mechanical influences such as vibrations or oscillations do not have a negative impact. REO's heavy duty components have been specially designed to cope with these environmental conditions. Their special design ensures maximum protection from mechanical, chemical or biological influences, enabling excellent functional safety and a long life cycle. Thanks to our experience, REO products are renowned for their reliability under the most adverse conditions.







To provide the necessary outdoor protection against pantograph abrasion, brake dust, metal abrasion, snow and ice, our components are silicone coated in addition to impregnation.

REO INSULATION SYSTEM PROTECTING COMPONENTS



MPS-Protective cover by REO

The Moisture Protection System (MPS) protective coating is an essential element of REO's insulation system and is one of the greatest USPs of REO's components. Our specially developed MPS protective coating is available exclusively from REO. It provides your components with long-term, reliable protection from all kinds of environmental influences. To provide the necessary outdoor protection against pantograph abrasion, brake dust, metal abrasion, snow and ice, our components are finished with this special protective coating in addition to VPI impregnation. This gives you the opportunity to expose the built-in components (IP20) to unfiltered cooling air; a major benefit with



regard to railway construction flexibility. REO uses this MPS protective coating for pollution degree PD3A or higher. REO offers this protective coating in REO Extreme or REO Mix and Match format.



With REO Mix & Match, you can choose from a wide range of options to get the best possible product for your use.

The benefits of REO insulation systems

- ▶ Best level of protection from moisture
- ▶ Excellent protection from stone chips
- ▶ High level of abrasion resistance (desert sand resistant)
- ▶ Suitable for pollution degree > PD3
- ▶ High level of tracking resistance (CTI > 600V)

High protection rating and ultra-stringent tests

In order to ensure the safety of persons and components, REO provides high levels of protection. At present, we offer a protection class value of up to IP67 in a wide range of products. REO components must prove their high resistive value under the most stringent of test conditions. These include shock and vibration tests, salt spray tests, cold and heat tests or tests regarding impermeability or fire protection.

Measurement and testing methods

Quality assurance is a top priority for REO. REO products only leave our factory if we are absolutely certain about their quality and performance. This safeguards a consistent level of quality across all products, components and complete solutions, representing everything that REO has ever stood for, namely top quality and robust products that require little maintenance. The very latest measuring technology, keeping at pace with the state of the art at all times, ensures the products we supply are of the very best quality. By carrying out these checks and inspections, we can, in good conscience, assume long life cycles in excess of 30 years in some instances. Thanks to these top quality components used and associated shorter maintenance intervals, the lifecycle costs, which are increasingly becoming a key reason for making purchases for many of our customers,

are comparatively low. As a consequence, REO customers benefit from an efficient product with low service costs over its entire life cycle.

Quality testing on your premises

Would you like to test your components? REO offers a broad portfolio of products for test benches and test equipment used for electronic components. We can provide you with a broad portfolio of products,

ranging from individual components to resistive, inductive and capacitive loads, right through to complete test systems for inverter testing purposes. All components are made at our German sites and fulfil the most stringent quality and safety standards. ◀

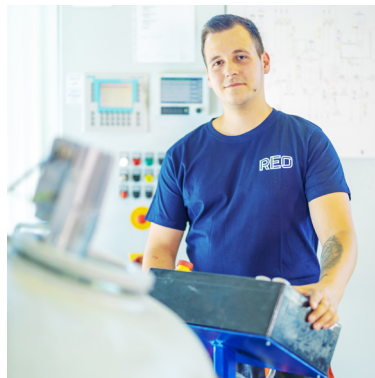

VPI impregnation of the components in the immersion tank at the Kyritz site



Testing technology from REO



Intensive testing and inspection methods ensure our products are top quality



REO components are tested and examined under the most adverse conditions. Together with carefully selecting the raw materials used, we manage to achieve a level of longevity and durability that is unparalleled globally.

REO PRODUCT LANDSCAPE

WHETHER YOU ARE LOOKING FOR CHOKES OR CURRENT TRANSFORMERS, WE HAVE THE RIGHT COMPONENTS FOR YOUR APPLICATION!

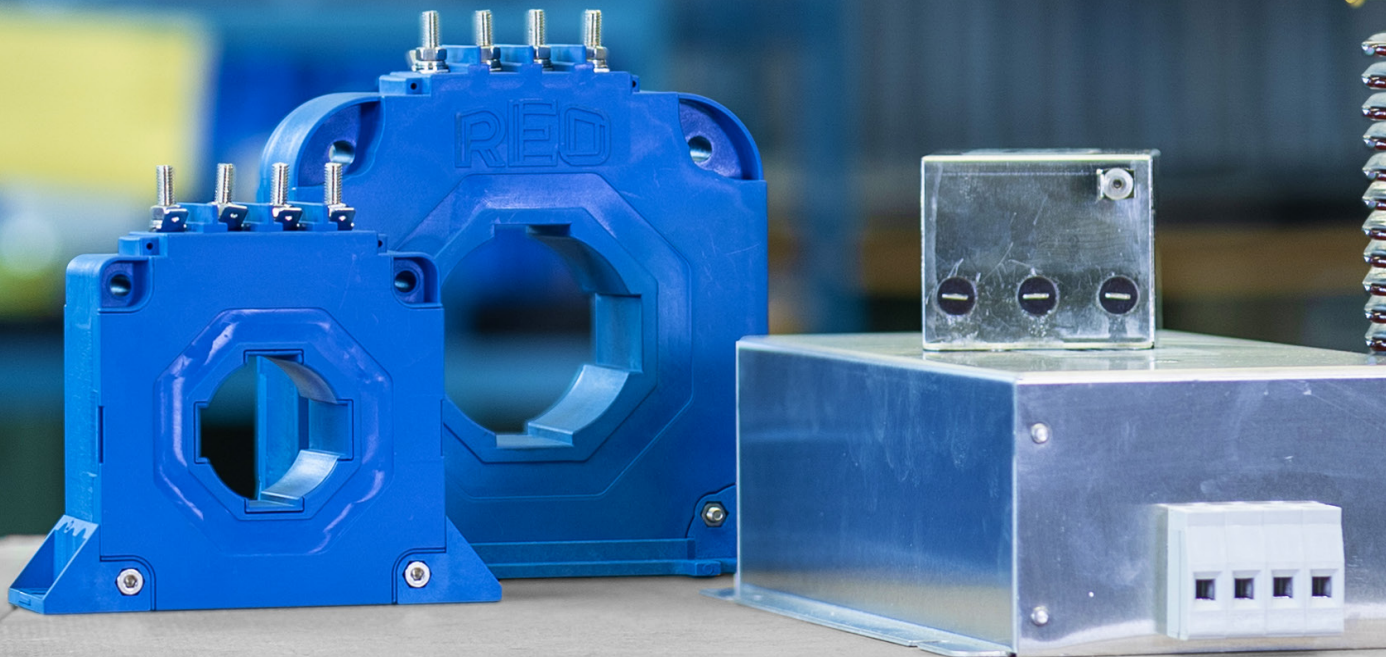

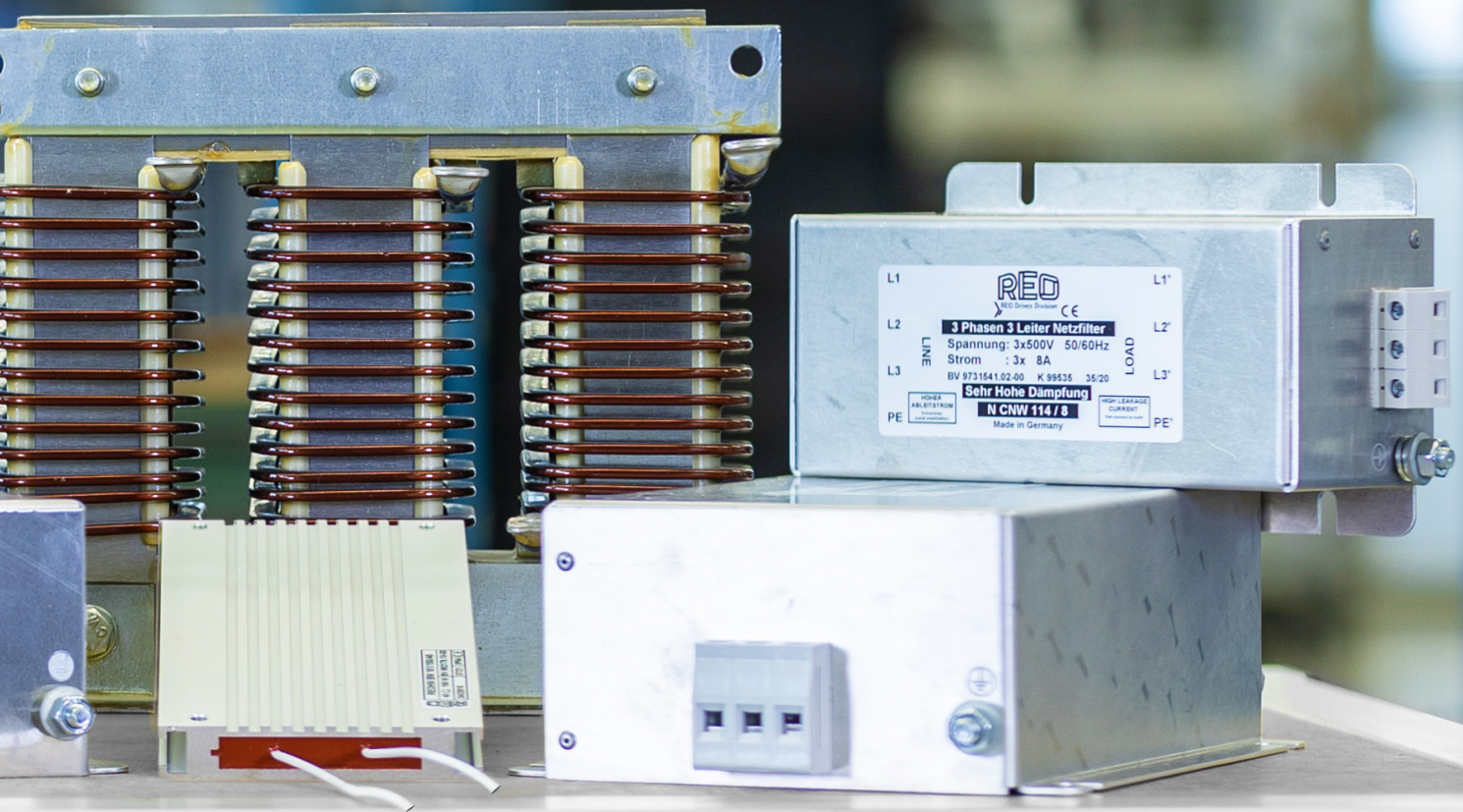

CHOKES

ENSURING SAFE OPERATION



Maximum flexibility in the design

Chokes need to fulfil all kinds of different requirements when used in railway settings. In order to satisfy the various demands of our customers, REO offers all kinds of different choke designs as standard. Here you can choose between air chokes, iron chokes and so-called coated core chokes. Each of these three choke types can be used for all kinds of different applications thanks to their typical features - we are of course on hand to help you make your choice. ◀

Benefits of chokes

- ▶ Having the correct choke for your application at any time
- ▶ Developed and tested as per IEC 60310
- ▶ Vibration and shock tested as per DIN EN 61373
- ▶ Reduction in EMC problems
- ▶ Pollution degree up to PD4A / protection rating IP66 possible
- ▶ REO manufactures its products according to European fire safety standard EN 45545
- ▶ Individual solutions adapted to your application

Performance spectrum of REO chokes

Chokes*		
Type	Air chokes LD	Iron chokes ED
Rated current DC/AC	up to 2500 A	
Inductance	up to 100 mH (depending on power)	
Linearity L(I)	constant	variable

Comparison between NTT chokes

Type	Air chokes LD 100	Air chokes LD 200	Air chokes TD	Iron choke ED	Cylinder core choke SD	Coated core choke LFD
Linearity L(I)	★★★	★★★	★★★	★★	★★	★★
Frequency response L(f)	★★	★★	★★★★	★★★★	★★★★	★★
Construction size (energy density)	★★	★★★	★	★★	★★★★	★★
Stray field (excluding screening)	★	★	★★★★	★★	★★★★	★
Short circuit resistance	★★★	★★	★★	★★	★★★★	★★
Price	★★★	★★	★	★★	★★	★

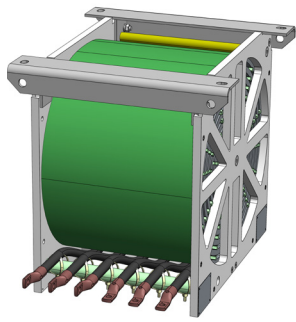
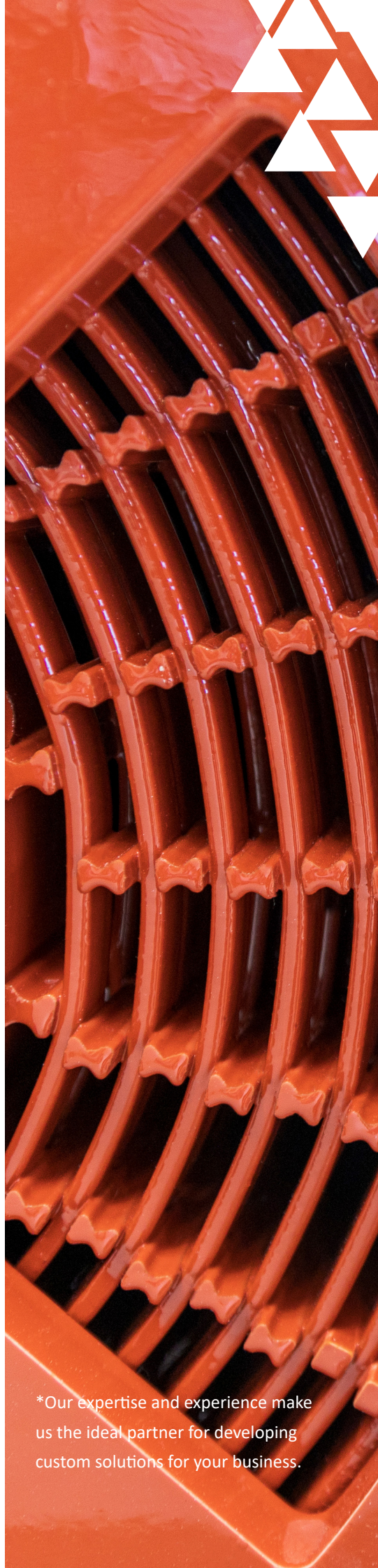

Air choke LD 100

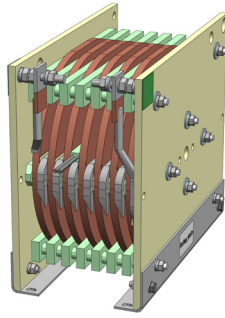

Air choke LD 200

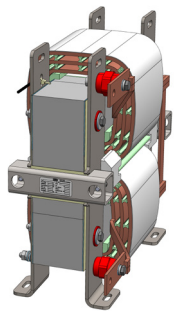

Iron choke ED

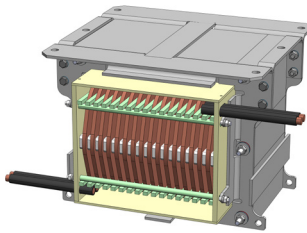

Coated core choke LFD

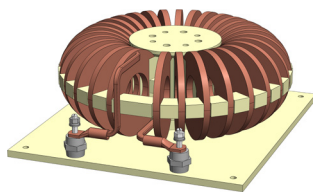

Air choke TD

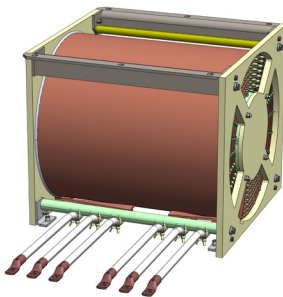

Cylinder core choke SD

Perfection in choke production,
right down to the smallest detail

*Our expertise and experience make
us the ideal partner for developing
custom solutions for your business.

TRANSFORMERS

EFFICIENT AND POWERFUL



Certified transformers ensuring safety and comfort

REO develops and produces railway transformers for auxiliary converters in the mains frequency range in particular, along with transformers such as those used for battery charging systems in the HF range, for example. Our components are ultra reliable and can be used on metros, in trams, locomotives, trolley buses, etc.. Space-saving components that are safe and long-lasting are required in particular in railway settings, where it is essential to provide the best possible levels of comfort and safety for passengers. ◀

Benefits of transformers

- ▶ Vibration and shock tested as per DIN EN 61373
- ▶ High degree of efficiency
- ▶ Low idle losses
- ▶ High level of environmental strength
- ▶ Protection rating IPX5
- ▶ Pollution degree PD4
- ▶ Low noise emission / structure-borne noise decoupled
- ▶ Weight optimised
- ▶ Available with integrated stray core as well as in stray field transformer format

Performance spectrum of REO transformers

Railway transformers*	
Rated power P_{nom}	up to 1000 [kVA]
Voltage level	up to 800 [V]
Frequency	16 2/3 Hz up to 100 [kHz] (NF/MF/HF)

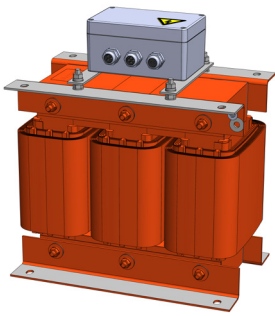

Three-phase transformer



Single-phase transformer

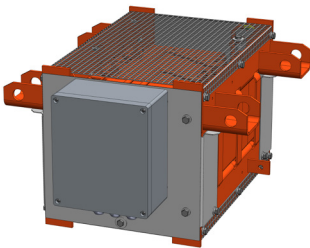

Galley-Transformer

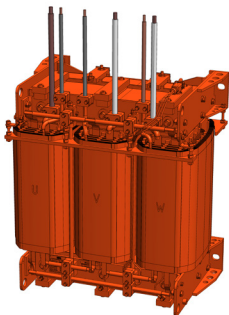

Leakage transformer

Transformer with MPS protective coating



*Our expertise and experience make us the ideal partner for developing custom solutions for your business.

RESISTORS

AIR OR WATER-COOLED



Efficient cooling specifically for heavy duty applications

REO NTT resistors have been specifically developed, produced and certified for use in railway and heavy duty applications. Air or water-cooled REO resistors are used in all kinds of different functions in railway technology, such as damping resistors or charge and discharge resistors. These resistors are therefore subject to specific requirements owing to their area of application. Excellent functional safety and life cycles combined with extreme resistance against adverse environmental conditions are therefore essential properties. This specially developed winding technology enables higher dielectric strength owing to the fact the wires in use are separated from each other. Protection ratings up to IP 66 can be achieved thanks to the profile design. The modular design ensures higher performance thanks to the combination of several resis-

tors. Liquid-cooled resistors from REO have outputs of up to 60 kW, which are significantly lower than traditional air-cooled resistors. ◀

Benefits of resistors

- ▶ Excellent mechanical protection
- ▶ Quiet
- ▶ Air or water-cooled
- ▶ High functional safety and life cycle
- ▶ Protection ratings from IP00 to IP66
- ▶ Vibration and shock tested as per DIN EN 61373
- ▶ Can be combined

Comparison of surface temperature, air-cooled vs. water-cooled

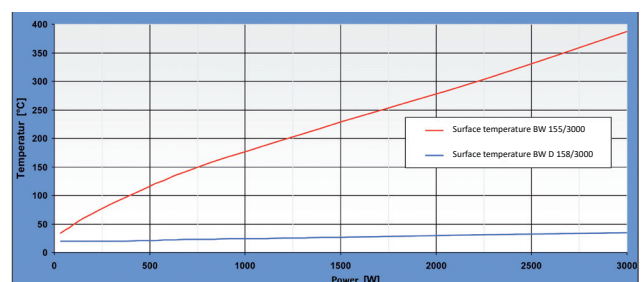

Performance spectrum of REO resistors

Resistors, air-cooled*	
Type	NTT R 153, NTT R 159
Continuous power	Up to 30 [kW]
Rated voltage	Up to 4.200 [V]
Protection rating	Up to IP66

Resistors, water-cooled*	
Type	BW D 330, NTT RD 158
Continuous power	Up to 60 [kW]
Rated voltage	Up to 4.200 [V]
Protection rating	IP20 - IP65

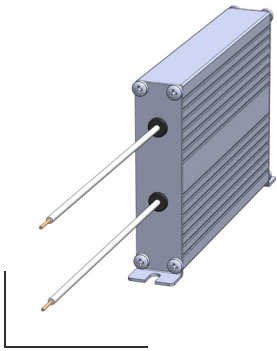

REOhm charging resistor NTT R 153

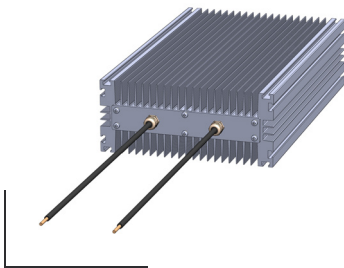

REOhm damping resistor NTT R 159

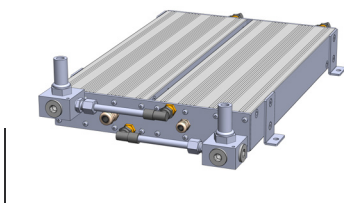

REOhm damping resistor NTT RD 158

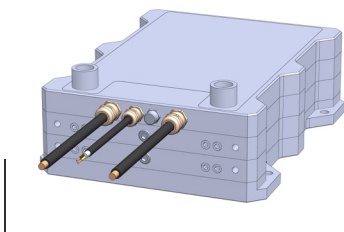

REOhm braking resistor BW D 330

High protection ratings ensure optimum protection.

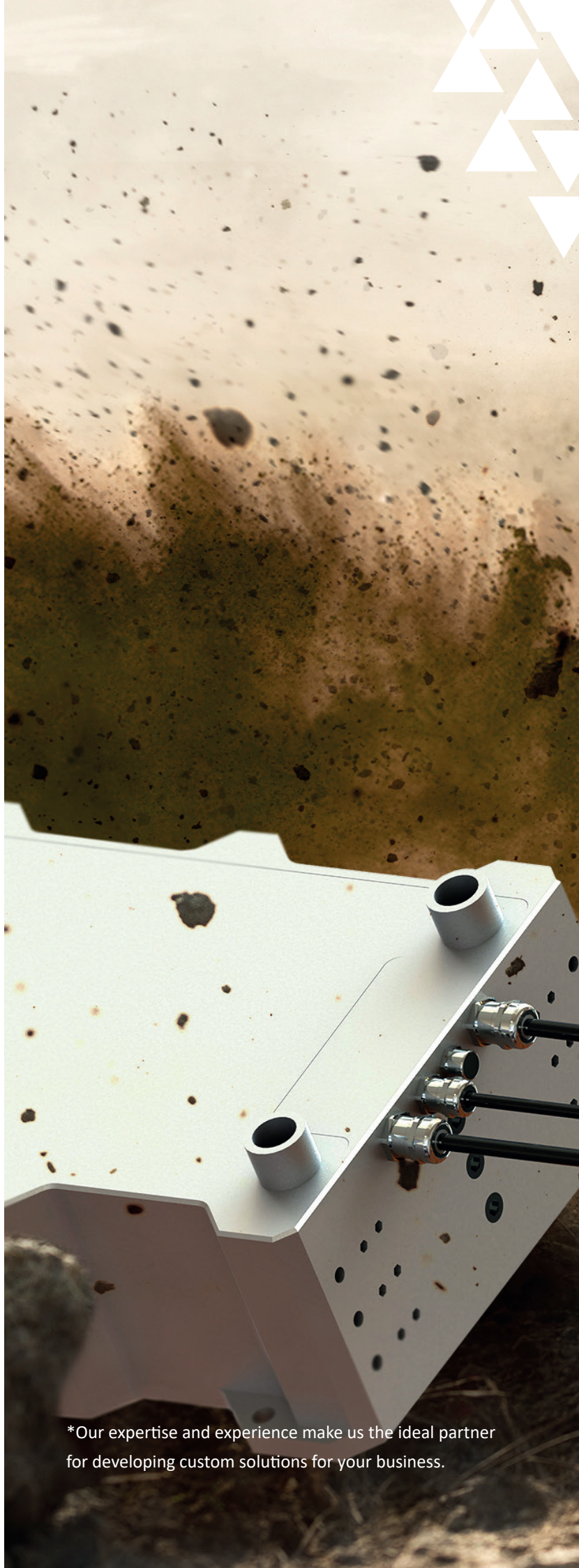

*Our expertise and experience make us the ideal partner for developing custom solutions for your business.

CURRENT TRANSFORMERS

ACTIVE AND PASSIVE CURRENT TRANSFORMERS FROM REO

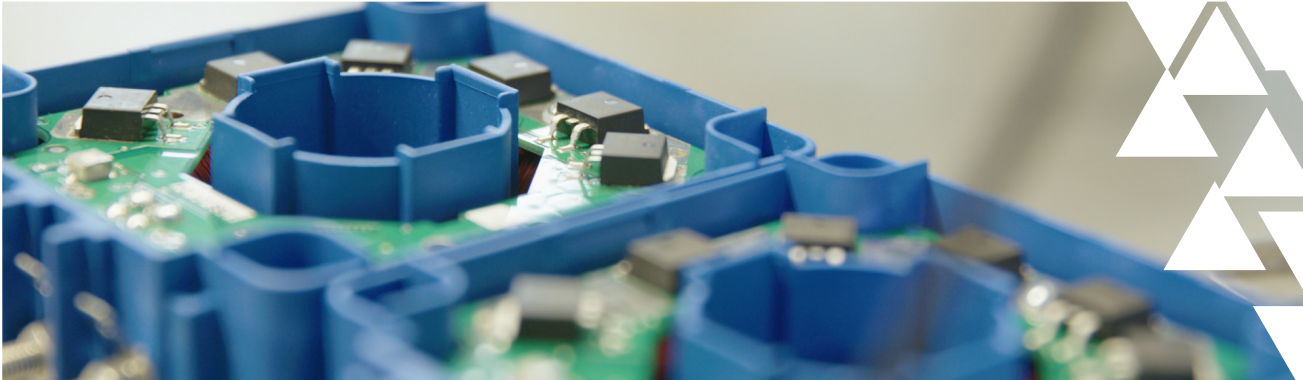

Diverse current and voltage transformers

REO current transformers distinguish themselves primarily due to their low space requirements, excellent linearity, short response times and their low iron and hysteresis losses. The WKO-2C-B current transformer with double-core technology and hall effect has an extended frequency response up to 120 kHz and an accurate phase response. The current transformers guarantee an improved current measurement accuracy of 0.5% in the whole frequency range: DC up to 120 kHz. They also have improved drift compensation and an extended temperature range of -40°C to 85°C.

They are also adapted perfectly to the corresponding operation site and meet DIN EN 50178 standards. ◀

Benefits of current transformers

- ▶ Safe electrically isolated primary and secondary circuits
- ▶ High current measurement accuracy
- ▶ Non-critical with overload currents
- ▶ Ultra reliable
- ▶ Tough enclosure designs (horizontal or vertical mounting) with different variants for push-through openings
- ▶ Variable connections (clamps, plugs, flat-cable plugs, cables, etc.)
- ▶ Vibration and shock tested as per DIN EN 61373 Category 1 Class B (only for WKO and WDI types in AT enclosure)

Performance spectrum of REO current transformers

Current transformers*		
Primary nominal current	IPN	0 to 3.000 [A]
Maximum Primary nominal current	I _{maxPN}	1,2 to 2 times [I _{PN}]
Secondary current	I _{aN}	0 to 1.000 [mA]
Ambient temperature	TA	-40 to +85 [°C]
Insulation test voltage	VP	6 [kVac]

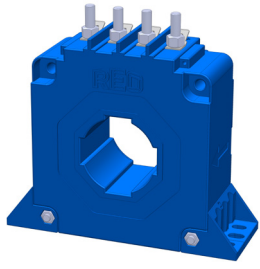

WKO-2C-B

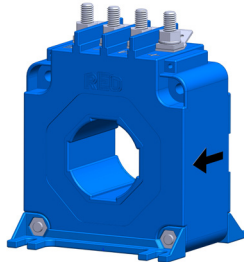

WKO-2C-B

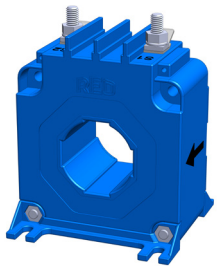

Series IE modular - frontal

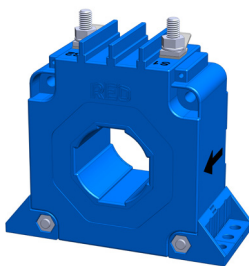

Series IE modular - lateral

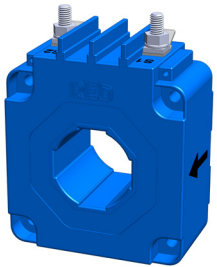

Series IE modular

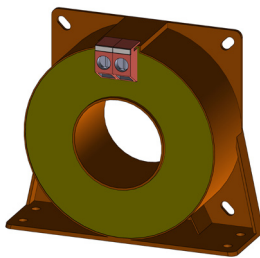

Series IN

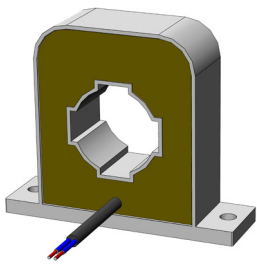

Series IN-B

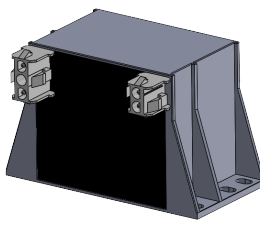

62B19001-current transformer

REO current transformer
in compact design

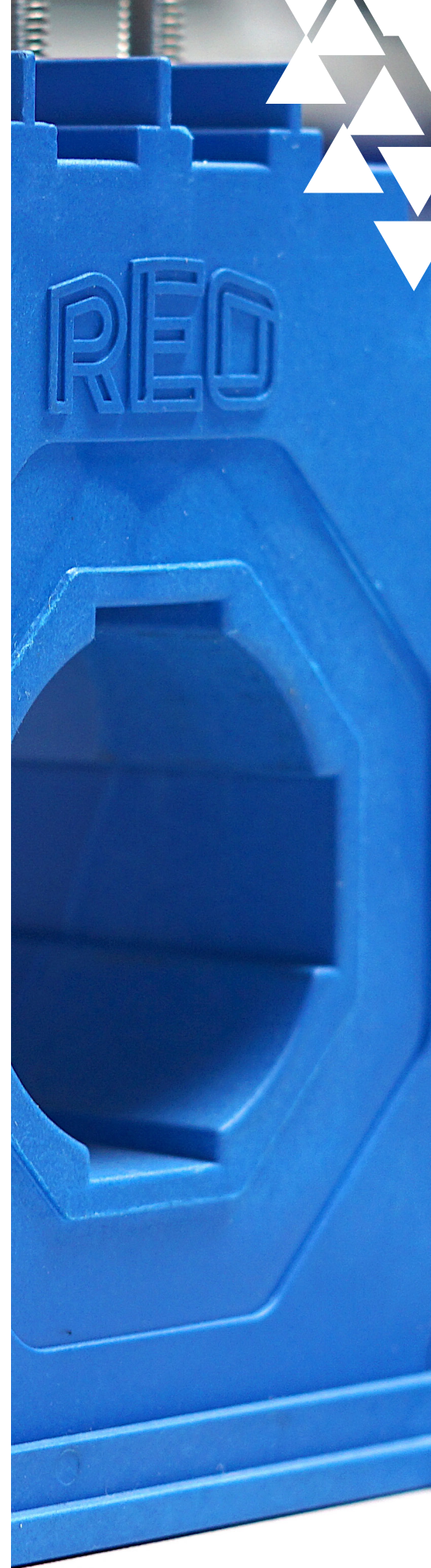

*Our expertise and experience make us the ideal partner for developing custom solutions for your business.

REO COMPLETE SOLUTIONS

REOFLEX MULTIUSE-FRAME BY REO



The flexible support frame system

The REOFLEX Multiuse-Frame support frame system is a fixing system for transformers, chokes or even braking resistors. This standardised support frame enables REO railway components to be assembled simply, quickly and particularly variably. To ensure safe absorption and suspension, shock absorbers may be integrated into the device as needed. This is assembled either under the roof construction (REOFLEX NTT TK D) or under the floor (REOFLEX NTT TK U) of trains. The support frame can be used in a variety of way, such as with mining trucks. The compact unit provides you with a fully mountable component that can even withstand extreme loads. ◀

Typical applications

- ▶ Railway technology
- ▶ Mining Trucks
- ▶ Shipbuilding
- ▶ Buses
- ▶ Industry

Benefits

- ▶ Compact solution
- ▶ Available as roof or underfloor construction
- ▶ Standardized system:
- ▶ One frame, suitable for use with a many different components
- ▶ Easy and flexible assembly of components

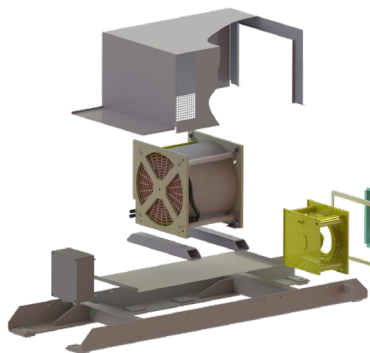

Exploded view of support frame

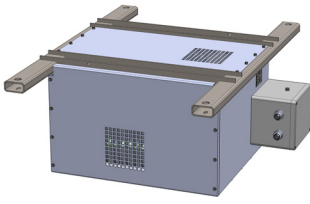

Support frame underfloor assembly with choke

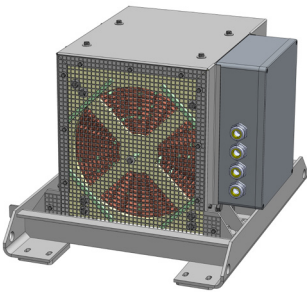

Support frame for a truck deck with air choke-fan combination

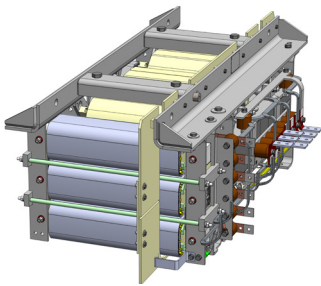

Support frame underfloor application with choke

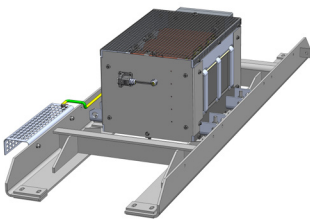

Support frame for roof construction with transformer

Support frame system
from REO



WERE YOU UNABLE TO FIND
THE RIGHT PRODUCT?

PLEASE VISIT OUR WEBSITE AT WWW.REO.DE!





100 YEARS OF REO

LOOKING FIRMLY TO THE FUTURE – MADE IN GERMANY



“As a fourth-generation family company, coherence has set us apart for almost 100 years. Our staff as well as our business partners and service providers are our focus if performance and motivation are rewarded. Personally, this makes me very proud as it means we can compete effectively with our philosophy internationally, even against other companies where there is usually a different corporate culture.”

Philip Twellsieck, CEO

Inductive, resistive and electronic components

REO AG is a fourth-generation family business. Almost 100 years of history have made REO AG one of the market leaders in the development and production of inductive, resistive, and electronic components and complete solutions, whilst also being an innovation driver in drive and railway technology, in medical, testing,



and conveyor technology, as well as in power electronics. With headquarters in Germany, 11 locations worldwide, 400 employees, and more than 11,000 world-class products, we are represented on international markets and stand for quality and efficiency.

Would you like to know what we have in mind for the future?

Keep abreast of the latest developments by signing up to our free newsletter today. Each month, you will find out about our latest products, developments and projects. For weekly updates, please follow us on Instagram or LinkedIn. ◀

Foundation in Berlin

1925

Construction of a permanent establishment in Solingen

1946

Foundation of the first foreign branch in Paris

1977



REC

Acquisition of the company
SETZERMANN in Pfarrkirchen

1981

Foundation of the branch in
England

1990

Foundation of the branches in
Italy and the USA

2000

1989

Foundation of the branch in
Switzerland

1991

Foundation of the
company IBK in Kyritz

A world map with a light beige background. The map is overlaid with numerous blue circular pins, each containing the REO logo. Several pins are accompanied by national flags: the United States flag is placed over North America; the United Kingdom, Germany, France, Switzerland, Spain, and Italy flags are placed over Europe; and the Turkish flag is placed over Turkey. The map also shows the outlines of South America and Africa.

REO: A GLOBALLY SUCCESSFUL FAMILY

Foundation of the branch in
Poland

2001

Foundation of the branch in
Spain

2002

Acquisition of the company
Nieke in Hennigsdorf

2004

2003

Foundation of the sales company in
China



Foundation of the branch in
India

2009



REO celebrates its
90th anniversary

2015

2010

Expansion of production sites in
China, USA, India, and foundation
of sales company in Turkey

2017

Foundation of REO Digital Connect
4.0 GmbH

Foundation of REO Inductive
Components FZCO in UAE

2021



REO Train Power Magnetics GmbH

Erasmusstraße 14
D-10553 Berlin
Tel.: +49 30 3670236 0
Fax: +49 30 3670236 44
zentrale.berlin@reo.de
www.reo-tpm.de